

LGR 6000LI

LOW GRAIN REFRIGERANT DEHUMIDIFIER

MANUFACTURING DATE: 03/2022 - PRESENT

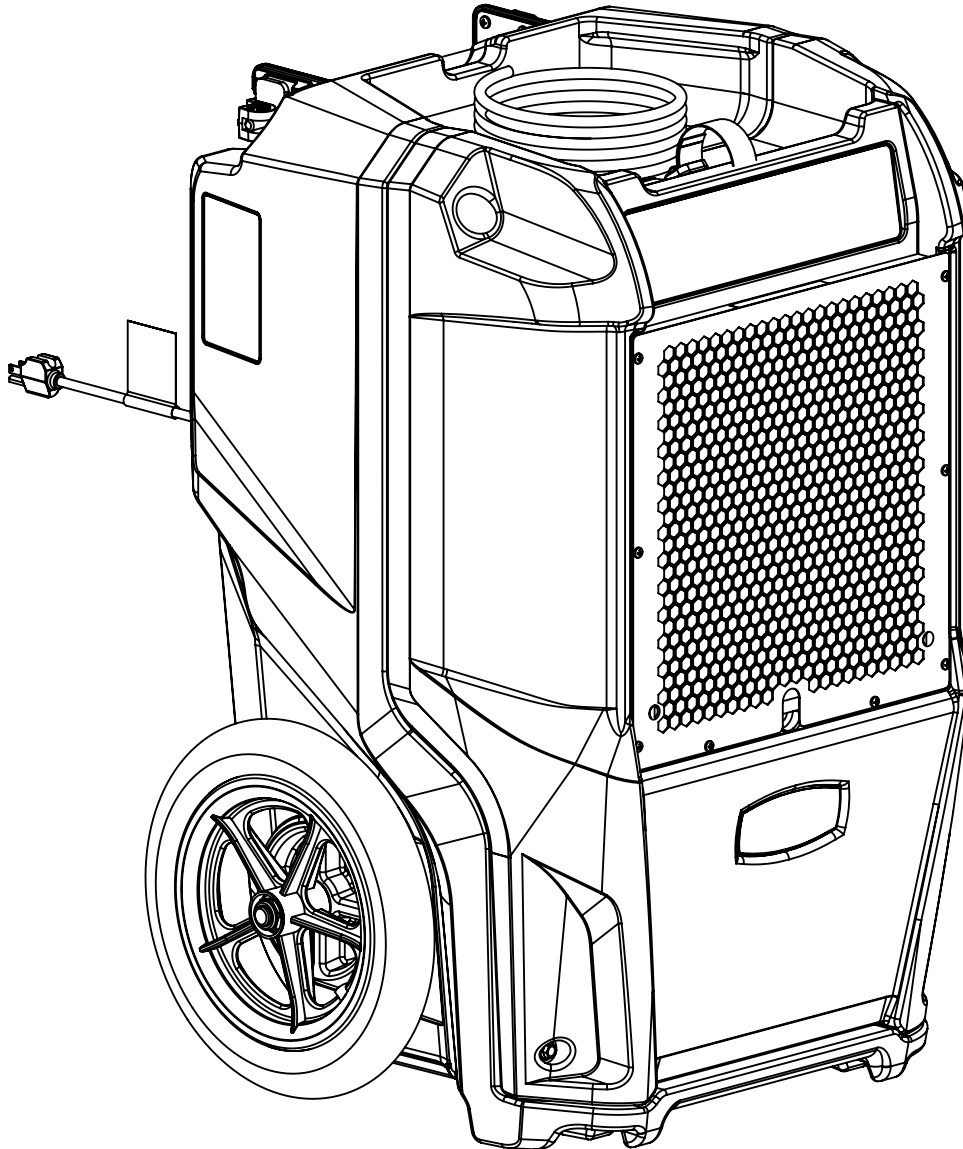

Parts are available through Legend Brands distributors. To locate a distributor near you, visit [Legendbrandsrestoration.com/Dealer-Search](https://www.legendbrandsrestoration.com/Dealer-Search)
For technical questions, visit [info.LegendBrands.com](https://www.info.LegendBrands.com) or email service@legendbrandsrestoration.com

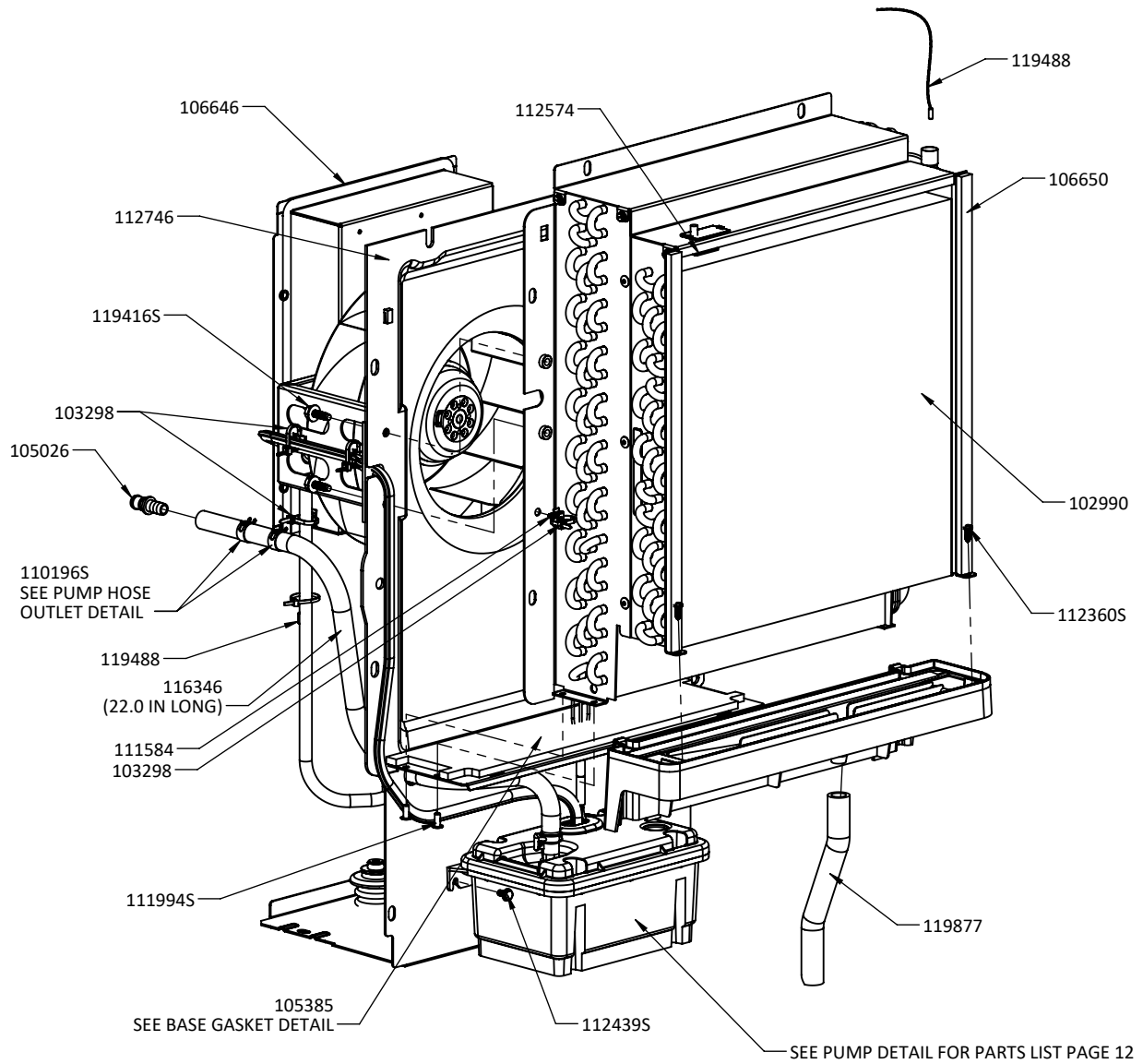

REFRIGERATION ASSEMBLY

PART NO.	QTY	UNIT	DESCRIPTION
119877	4	IN	TUBE - 1/2 ID X 3/4 OD VINYL
119488	2	EA	SENSOR CABLE ASSY - MICRO CONTROLLER TEMP DEFROST DEHUS
119416S	4	EA	SCREW - M6 X 18MM HWH NYLOC XYP MATPOINT
116346	24	IN	TUBING - 3/8 X 5/8 OD BRAIDED PVC
112746	1	EA	SHROUD - IMPELLER ABS BLK F600
112574	1	EA	SENSOR ASSY - TEMP/RH SHT31 36"
112439S	2	EA	SCREW - #10-24 X 3/8 HWH SER ZP
112360S	2	EA	SCREW - #8 X 1/2 PH TRUSS SS
111944S	2	EA	RIVET - 3/16 X 1/4 STL/STL ZP
111584	4	EA	PUSH MOUNT - NYLON TIE
110196S	2	EA	CLAMP - HOSE 5/8 DIA SPRING STL ZP
106650	1	EA	GASKET - 1/2 X 1/2 PVC PSA
106646	65	IN	GASKET - .375 X .125 CLOSED CELL NEOPRENE / VINYL / NITRILE
105385	1	EA	GASKET - CONDENSER BASE PVC PSA LGR 6000LI
105026	1	EA	FITTING - QUICK DISCONNECT INSERT 3/8 BARB (MALE)
103298	5	EA	CABLE TIE - 6 NYLON
102990	1	EA	COIL ASSY - EVAP/COND R410A LGR 6000LI

Parts are available through Legend Brands distributors. To locate a distributor near you, visit Legendbrandsrestoration.com/Dealer-Search
 For technical questions, visit info.LegendBrands.com or email service@legendbrandsrestoration.com

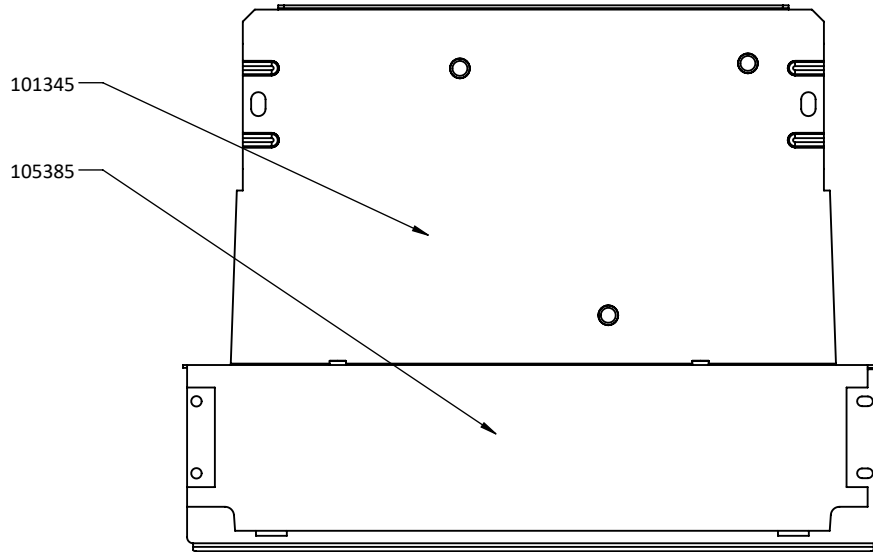

BASE GASKET DETAIL

PART NO.	QTY	UNIT	DESCRIPTION
105385	1	EA	GASKET - CONDENSER BASE PVC PSA LGR 6000LI
101345	1	EA	BASE - GALV STL LGR 6000LI

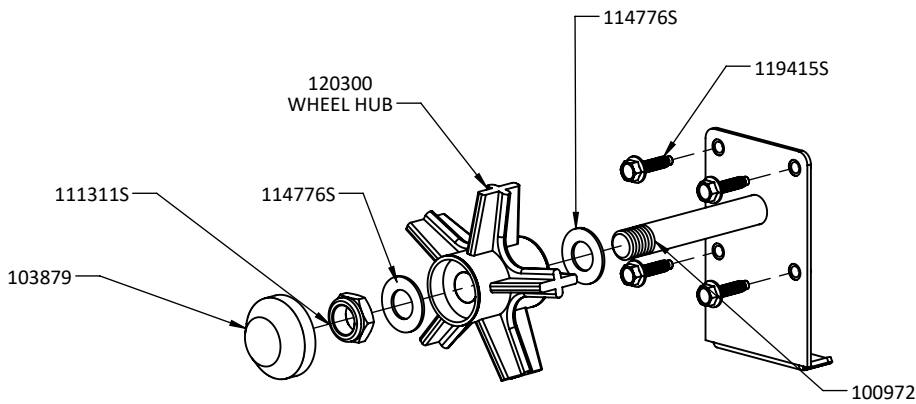

STUB AXLE ASSEMBLY

PART NO.	QTY	UNIT	DESCRIPTION
120300	1	EA	WHEEL - 12 X 2 X 5/8 BORE GRY
119415S	4	EA	SCREW - M6 X 1.0 X 25MM HWH NYLOC MATPOINT XYP BLK
114776S	2	EA	WASHER - 5/8 AN .640 ID X 1.187 OD X .06 SS
111311S	1	EA	NUT - 5/8-11 UNC THIN ZP
103879	1	EA	DUST CAP - 12 OD WHEEL NYLON BLK

Parts are available through Legend Brands distributors. To locate a distributor near you, visit Legendbrandsrestoration.com/Dealer-Search
 For technical questions, visit info.LegendBrands.com or email service@legendbrandsrestoration.com

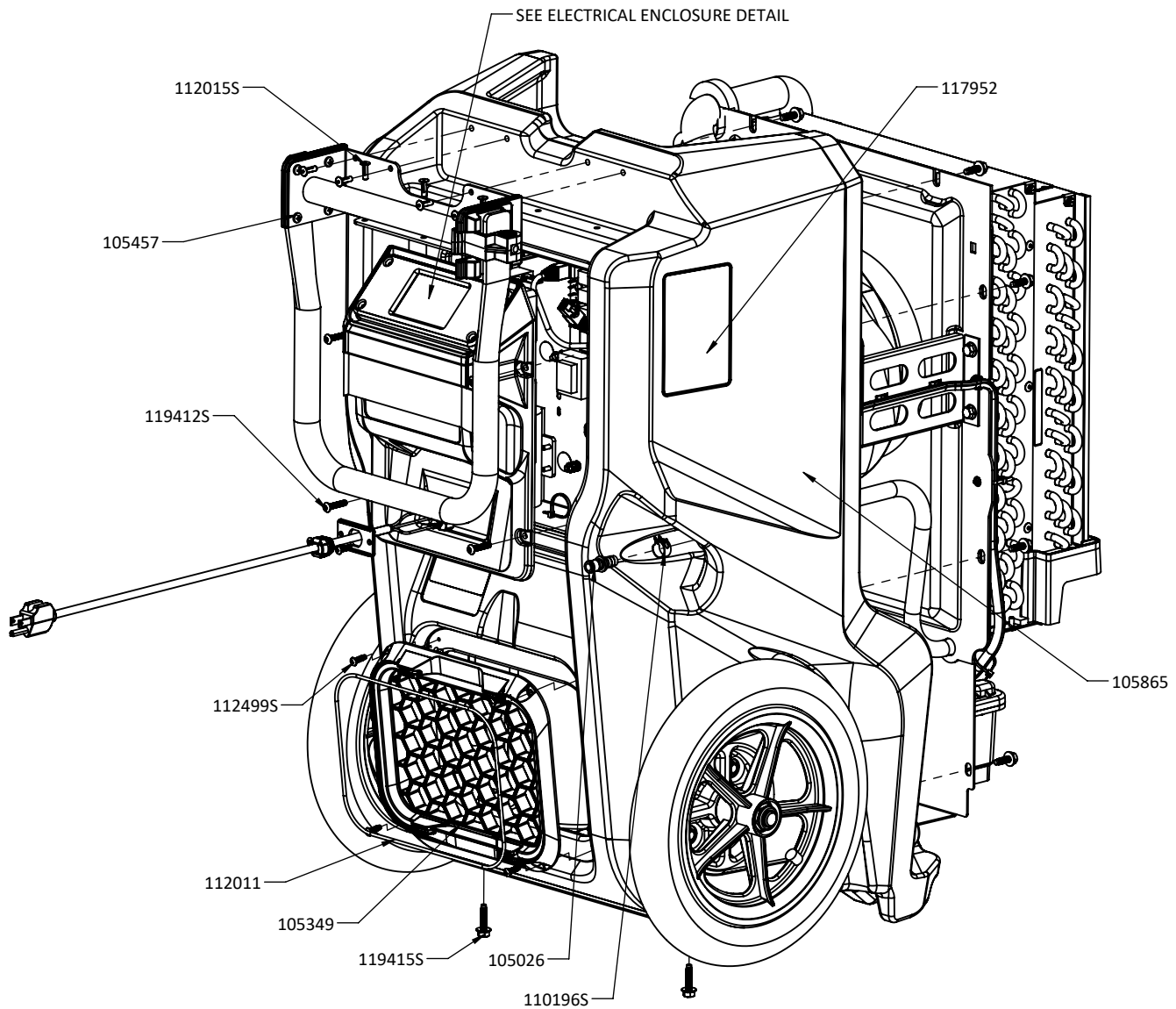

BACK PANEL ASSEMBLY

PART NO.	QTY	UNIT	DESCRIPTION
119415S	2	EA	SCREW - M6 X 1.0 X 25MM HWH NYLOC MATPOINT XYP BLK
119412S	4	EA	SCREW - M5 X .08 X 25MM BH TORX ZP BLK
117952	1	EA	LABEL - WARNING DEHUS
112499S	4	EA	SCREW - #10 X 5/8 HIGH LOW PHP BLK
112015S	7	EA	RIVET - 3/16 X 5/8 TRI FOLD AL/AL
112011	1	EA	RING - DUCT ATTACHMENT ZP LGR 6000LI
110196S	1	EA	CLAMP - HOSE 5/8 DIA SPRING STL ZP
105865	1	EA	BACK PANEL - POLYETHYLENE
105457	1	EA	HANDLE ASSEMBLY
105349	1	EA	GRILL - OUTLET ABS BLK F600
105026	1	EA	FITTING - QUICK DISCONNECT INSERT 3/8 BARB (MALE)

Parts are available through Legend Brands distributors. To locate a distributor near you, visit Legendbrandsrestoration.com/Dealer-Search
 For technical questions, visit info.LegendBrands.com or email service@legendbrandsrestoration.com

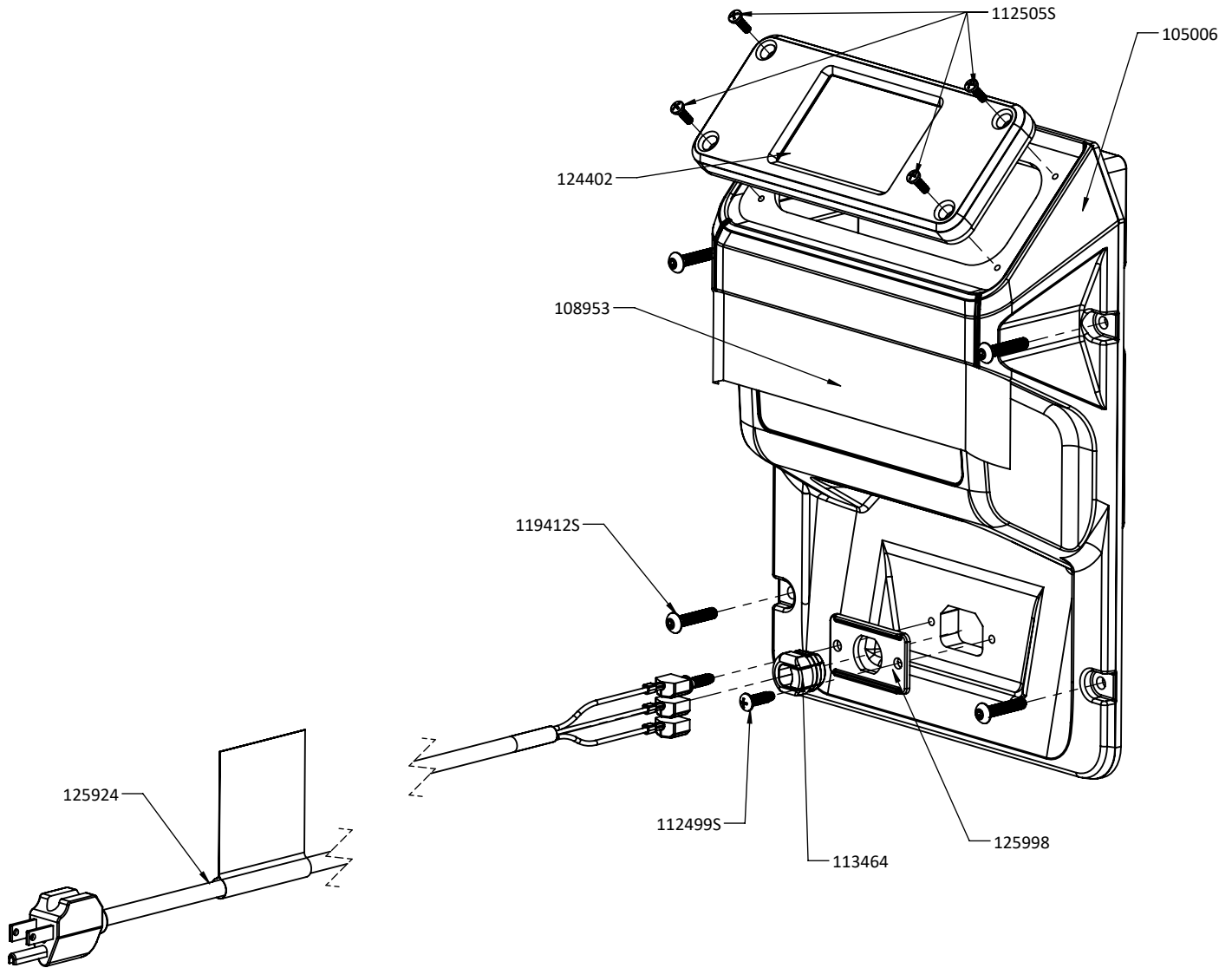

ELECTRICAL ENCLOSURE ASSEMBLY

PART NO.	QTY	UNIT	DESCRIPTION
125998	1	EA	PLATE - HEYCO MOUNT .125 WALL ABS BLK
125924	1	EA	POWER CORD ASSY - 14/3 SJTW 5-15P 4 IN ROJ 25 FT
124402	1	EA	KIT - COMMAND HUB
119412S	4	EA	SCREW - M5 X .08 X 25MM BH TORX ZP BLK
113464	1	EA	STRAIN RELIEF - .370 DIA X .13 BLK
112505S	4	EA	SCREW - #6 X 1/2 HI LOW PHP ZP BLK
112499S	2	EA	SCREW - #10 X 5/8 HIGH LOW PHP BLK
108953	1	EA	LABEL - OPERATING INSTRUCTIONS DEHUS
105006	1	EA	ENCLOSURE - ELECTRICAL BOX COVER ABS F600

Parts are available through Legend Brands distributors. To locate a distributor near you, visit Legendbrandsrestoration.com/Dealer-Search
 For technical questions, visit info.LegendBrands.com or email service@legendbrandsrestoration.com

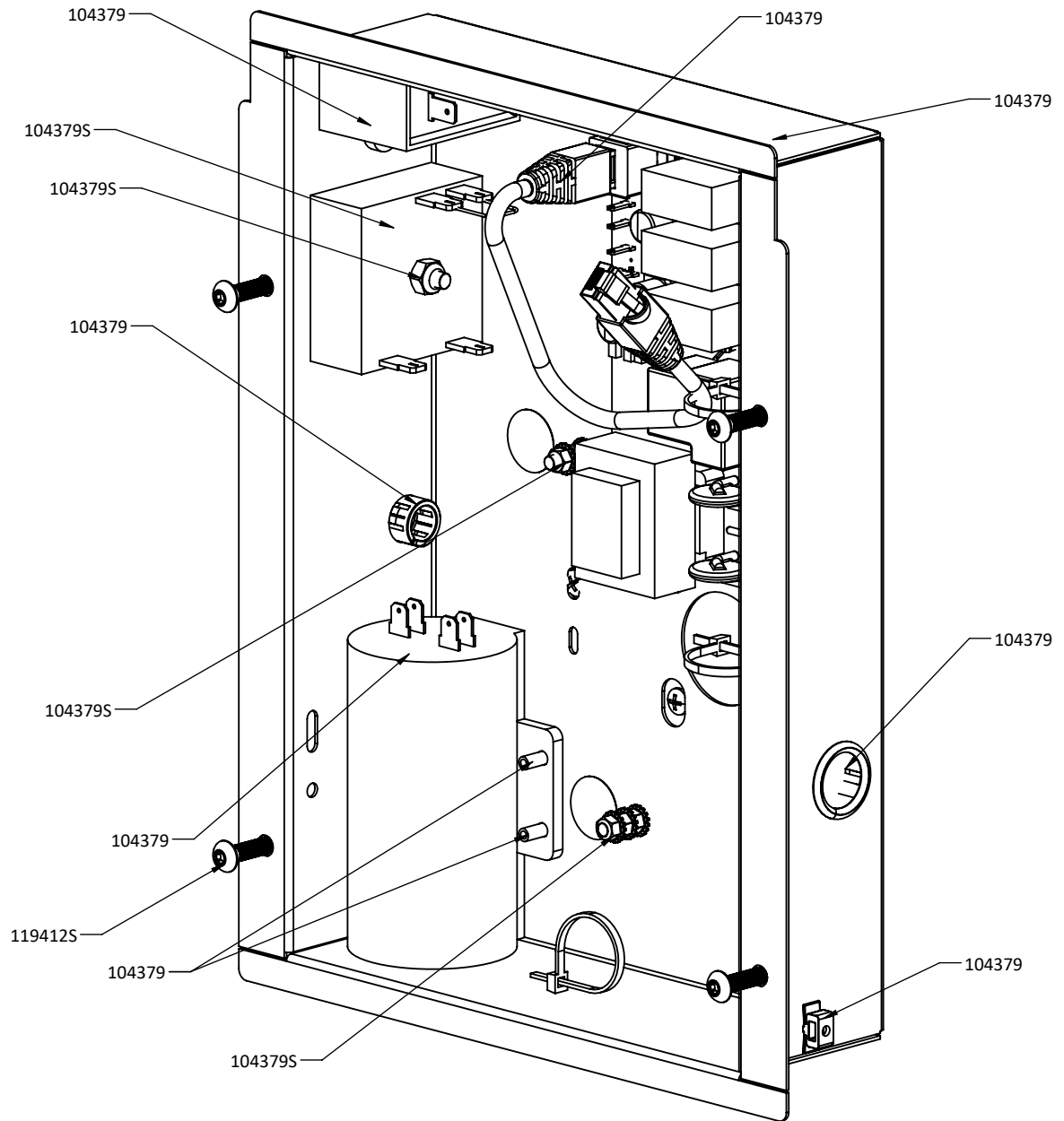

ELECTRICAL BOX ASSEMBLY

PART NO.	QTY	UNIT	DESCRIPTION
123086S	1	EA	NUT - #10-24 NYLOC ZP
119412S	4	EA	SCREW - M5 X .08 X 25MM BH TORX ZP BLK
116161	1	EA	ELECTRICAL BOX - GALV STL LGR 6000LI
114107	2	EA	RIVET - 5/32 X 3/8 AL/AL BLK ANOD
113059	1	EA	SPEED CONTROLLER - 120V 50/60 HZ LGR 6000LI
111584	1	EA	PUSH MOUNT - NYLON TIE
111307S	5	EA	NUT - #8-32 W/STAR WASHER ZP
103292	1	EA	CABLE ASSY - BLUE PATCH CAT 5E 1FT
103276	1	EA	BUSHING - .671 ID X .875 X .41 SPLIT NYLON BLK
102545	1	EA	CAPACITOR - 6MFD 440V (REVOLUTION)
102544	1	EA	CAPACITOR - 55MFD 370V 2.0 DIA ROUND W/MTG BRKT
102175	1	EA	BUSHING - .390 ID X .562 X .406 SPLIT NYLON BLK

Parts are available through Legend Brands distributors. To locate a distributor near you, visit Legendbrandsrestoration.com/Dealer-Search
 For technical questions, visit info.LegendBrands.com or email service@legendbrandsrestoration.com

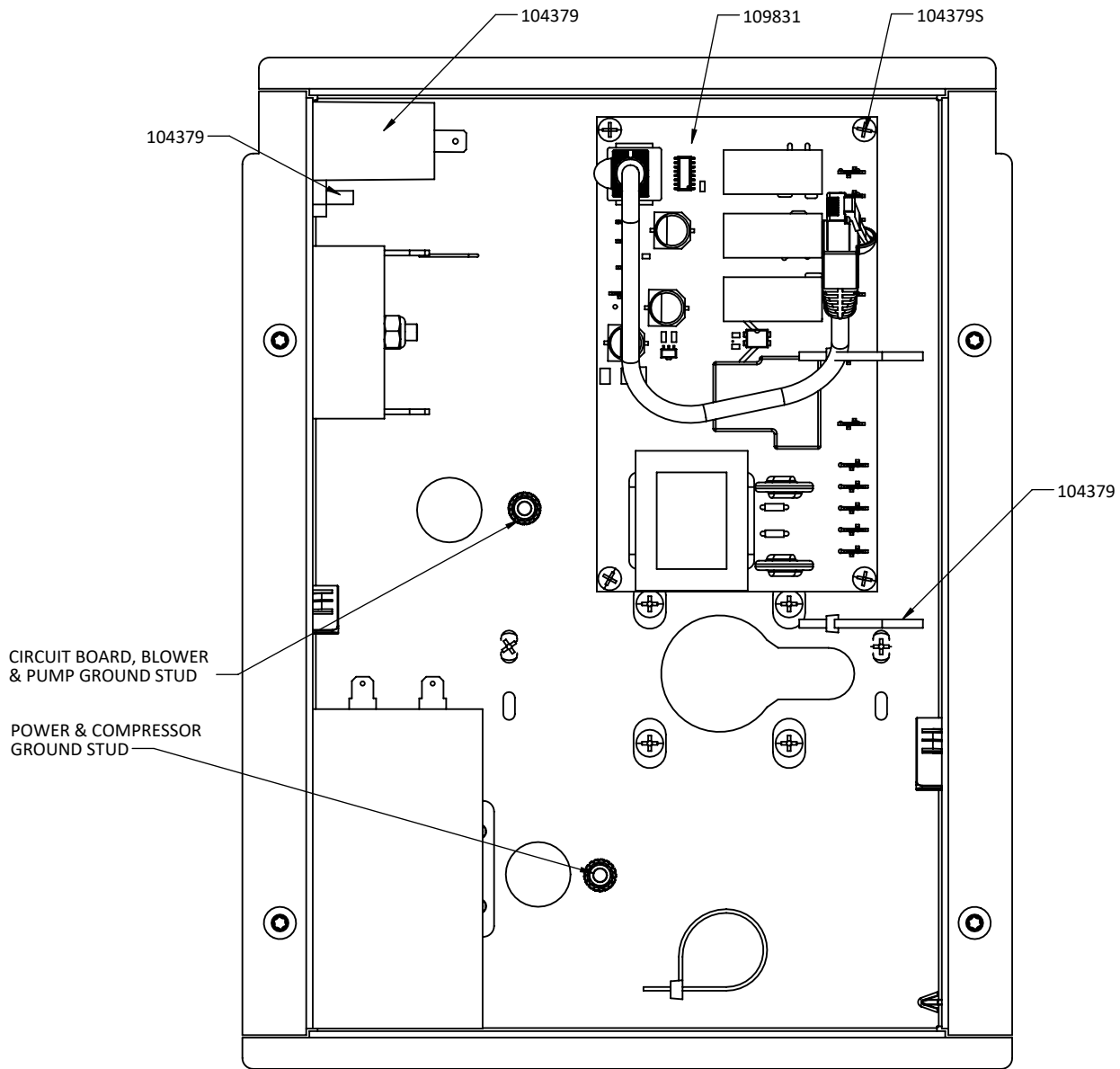

CIRCUIT BOARD ASSEMBLY

PART NO.	QTY	UNIT	DESCRIPTION
123095S	4	EA	SCREW - #6-32 X 3/8 PHIL PH ZP
114107	1	EA	RIVET - 5/32 X 3/8 AL/AL BLK ANOD
109831	1	EA	CIRCUIT BOARD ASSY - 115V HIGH VOLTAGE 2 SP
103298	2	EA	CABLE TIE - 6 NYLON
102545	1	EA	CAPACITOR - 6MFD 440V (REVOLUTION)

Parts are available through Legend Brands distributors. To locate a distributor near you, visit Legendbrandsrestoration.com/Dealer-Search
 For technical questions, visit info.LegendBrands.com or email service@legendbrandsrestoration.com

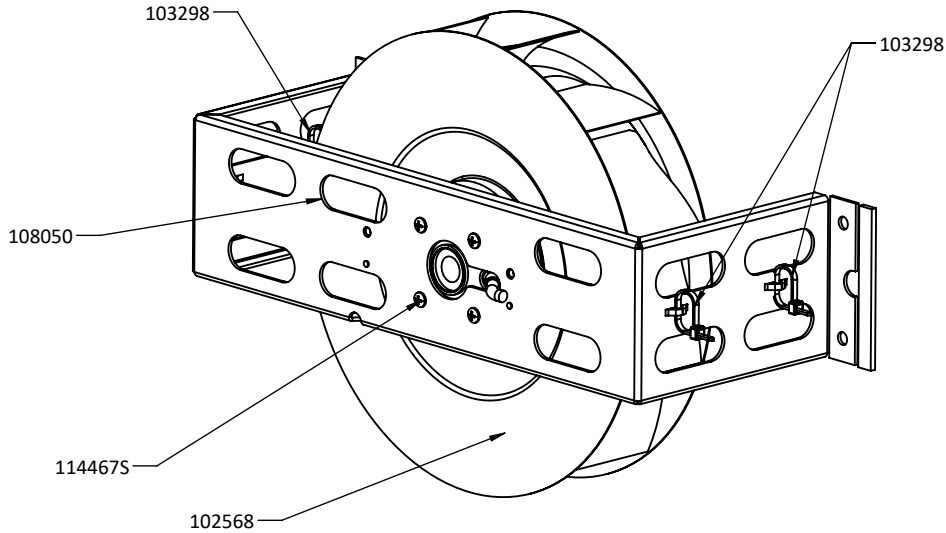

BLOWER ASSEMBLY DETAIL

PART NO.	QTY	UNIT	DESCRIPTION
114467S	4	EA	SCREW - M4 X 8MM PHP NYLOC ZP
108050	1	EA	BRACKET - MOTORIZED IMPELLER 250MM LGR 6000LI
103298	5	EA	CABLE TIE - 6 NYLON
102568	1	EA	BLOWER ASSY - MOTORIZED IMPELLER 115V 65W 1650 RPM 250MM

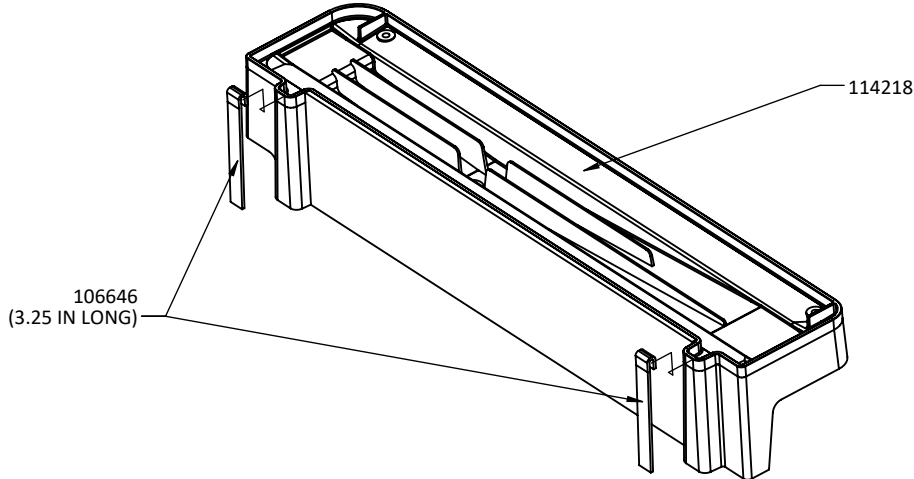

CONDENSATE TRAY DETAIL

PART NO.	QTY	UNIT	DESCRIPTION
114218	1	EA	TRAY - CONDENSATE ABS BLK F600
106646	.542	FT	GASKET - .375 X .125 CLOSED CELL NEOPRENE / VINYL / NITRILE

Parts are available through Legend Brands distributors. To locate a distributor near you, visit Legendbrandsrestoration.com/Dealer-Search
 For technical questions, visit info.LegendBrands.com or email service@legendbrandsrestoration.com

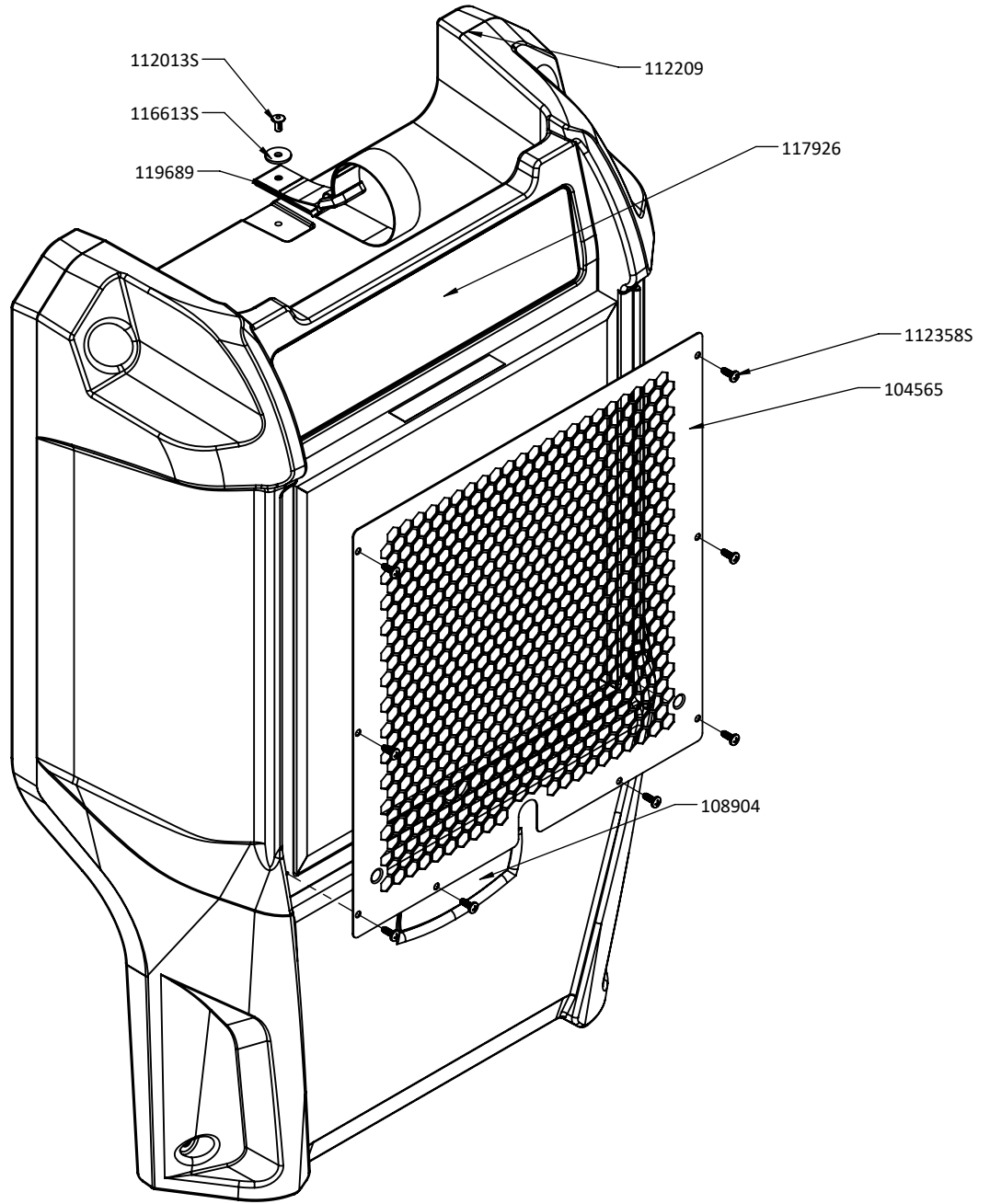

COVER DETAIL

PART NO.	QTY	UNIT	DESCRIPTION
119689	1	EA	STRAP ASSEMBLY
117926	1	EA	LABEL - PRODUCT LGR 6000LI (QR)
116613S	1	EA	WASHER - FLAT #10 TYPE B WIDE
112358S	8	EA	SCREW - #8 X 1/2 PHP ZP BLK
112209	1	EA	COVER - POLYETHYLENE FISHER BLUE LGR 6000LI
112013S	1	EA	RIVET - 3/16 X 3/8 TRI FOLD AL/AL
108904	1	EA	LABEL - BADGE
104565	1	EA	FILTER SHROUD - PC WR BLK LGR 6000LI

Parts are available through Legend Brands distributors. To locate a distributor near you, visit Legendbrandsrestoration.com/Dealer-Search
 For technical questions, visit info.LegendBrands.com or email service@legendbrandsrestoration.com

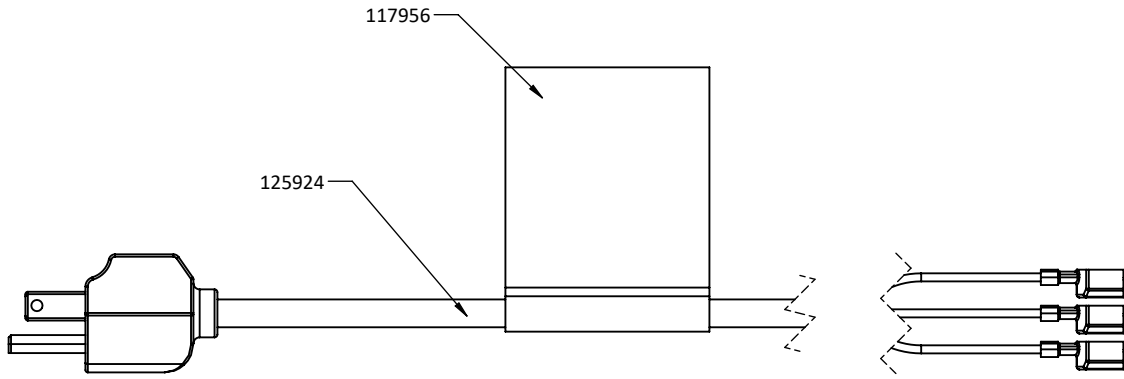

POWER CORD DETAIL

PART NO.	QTY	UNIT	DESCRIPTION
125924	1	EA	POWER CORD ASSY - 14/3 SJTW 5-15P 4 IN ROJ 25 FT
117956	1	EA	LABEL - WARNING POWER CORD DEHUS

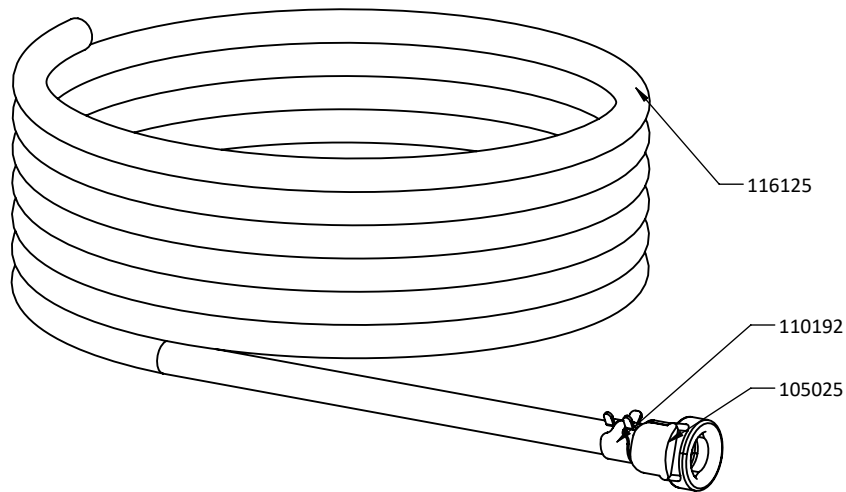

HOSE DETAIL

PART NO.	QTY	UNIT	DESCRIPTION
116125	1	EA	TUBE - 1/4 ID X 3/8 OD X 40FT VINYL
110192	1	EA	CLAMP - 3/8 ID HOSE GRN
105025	1	EA	FITTING - QUICK DISCONNECT BODY 1/4 BARB (FEMALE)

Parts are available through Legend Brands distributors. To locate a distributor near you, visit Legendbrandsrestoration.com/Dealer-Search
 For technical questions, visit info.LegendBrands.com or email service@legendbrandsrestoration.com

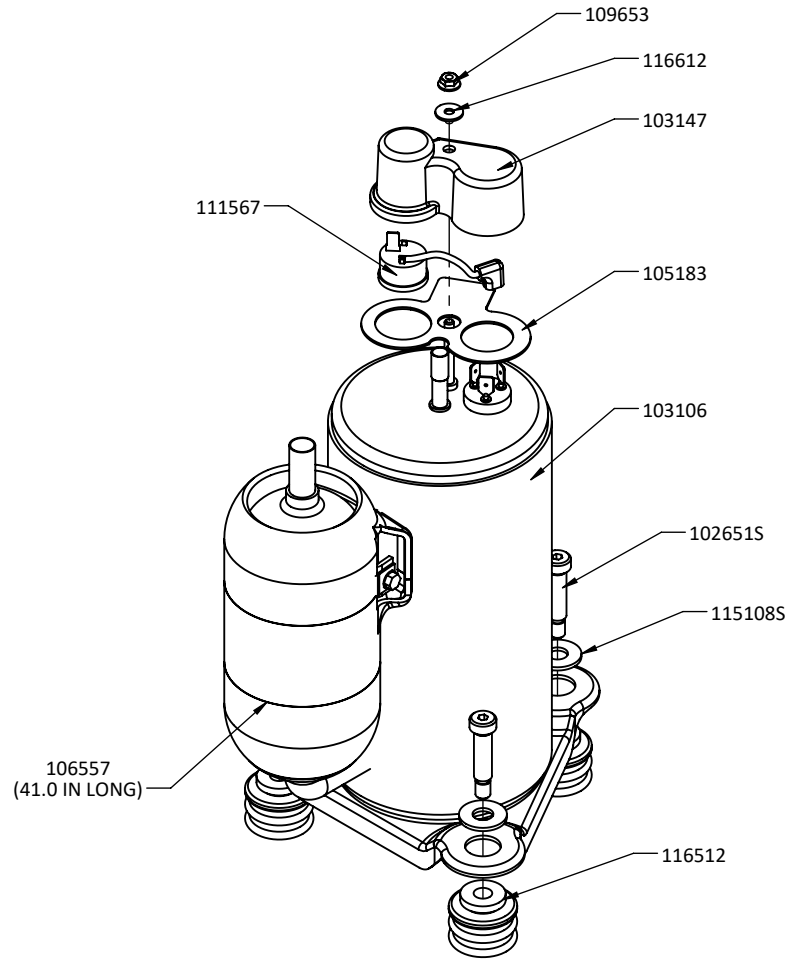

115V LG COMPRESSOR ASSEMBLY

PART NO.	QTY	UNIT	DESCRIPTION
116612	1	EA	WASHER - COMPRESSOR TERMINAL 115V LG 8600-R410A
116512	3	EA	VIBRATION MOUNT - COMPRESSOR 115V LG 8600-R410A
115108S	3	EA	WASHER - 3/8 USS .43 ID X 1.00 OD X .08 ZP
111567	1	EA	OVERLOAD - COMPRESSOR 115V LG 8600-R410A
109653	1	EA	NUT - COMPRESSOR TERMINAL COVER 115V LG 8600 R410A
106557	41	IN	INSULATION - CORK TAPE 2 X .13 PT1 (30 FT/RL)
105183	1	EA	GASKET - COMPRESSOR TERMINAL 115V LG 8600-R410A
103147	1	EA	COVER - COMPRESSOR TERMINAL - 115V LG 8600-R410A
103106	1	EA	COMPRESSOR - ROTARY 115V LG 8600 R410A
102651S	3	EA	BOLT - SHOULDER 5/16-18 X 3/8 X 1.25

115V PANASONIC COMPRESSOR ASSEMBLY

PART NO.	QTY	UNIT	DESCRIPTION
126496	1	EA	KIT-LG COMPRESSOR RETROFIT

Parts are available through Legend Brands distributors. To locate a distributor near you, visit Legendbrandsrestoration.com/Dealer-Search
 For technical questions, visit info.LegendBrands.com or email service@legendbrandsrestoration.com

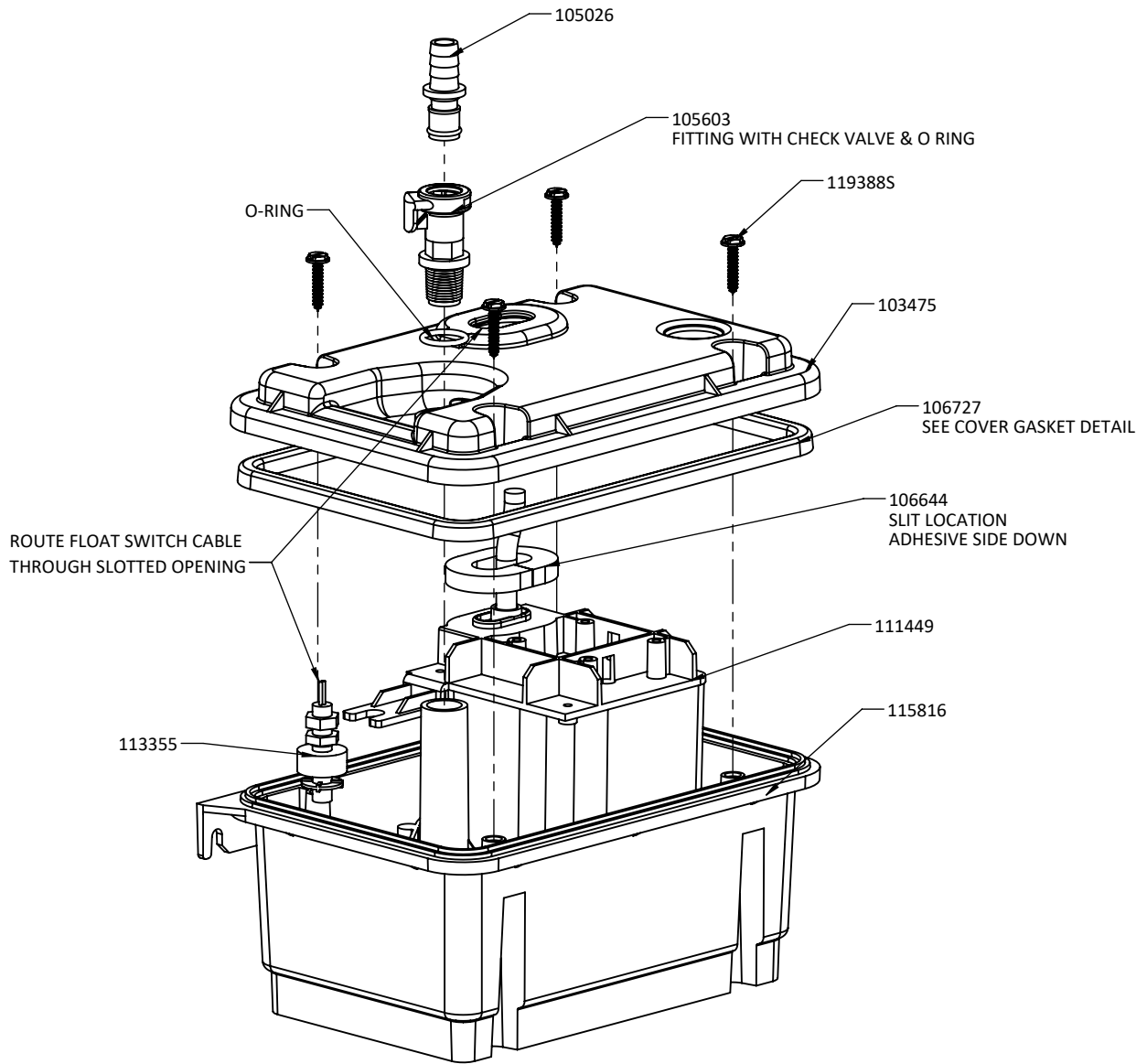

TANK ASSEMBLY

PART NO.	QTY	UNIT	DESCRIPTION
119388S	4	EA	SCREW - #6 X 3/4 SLT HWH SS
115816	1	EA	TANK - SUBMERSIBLE PUMP F600
113355	1	EA	SWITCH - SPLIT MAGNETIC FLOAT
111499	1	EA	PUMP - SUBMERSIBLE 115V 1.3 GPM 4FT CORD
106727	1	EA	GASKET - PUMP COVER SEAL EPDM
106644	1	EA	GASKET - PUMP CORD SEAL NEOP/EPDM PSA
105603	1	EA	FITTING - QUICK DISCONNECT BODY AND CHECK VALVE SUBMERSIBLE
105026	1	EA	FITTING - QUICK DISCONNECT INSERT 3/8 BARB (MALE)
103475	1	EA	COVER - TANK SUBMERSIBLE PUMP F600

Parts are available through Legend Brands distributors. To locate a distributor near you, visit Legendbrandsrestoration.com/Dealer-Search
 For technical questions, visit info.LegendBrands.com or email service@legendbrandsrestoration.com

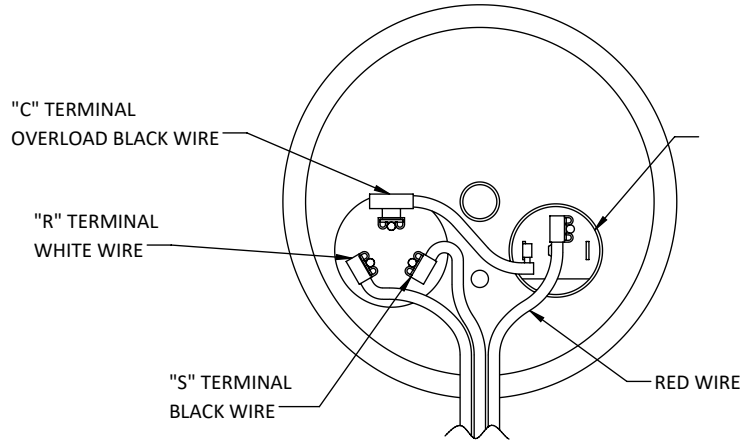

COMPRESSOR WIRING DETAIL

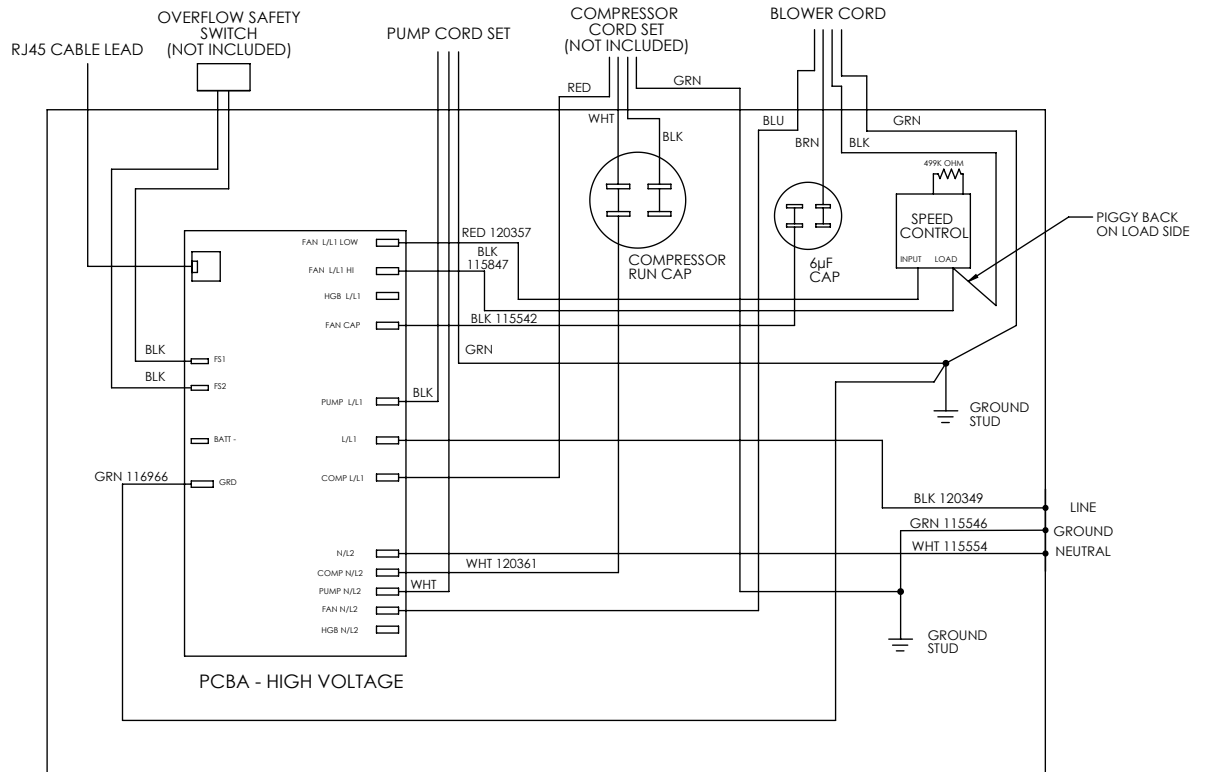

Parts are available through Legend Brands distributors. To locate a distributor near you, visit Legendbrandsrestoration.com/Dealer-Search
For technical questions, visit info.LegendBrands.com or email service@legendbrandsrestoration.com

DATE CODE LEGEND

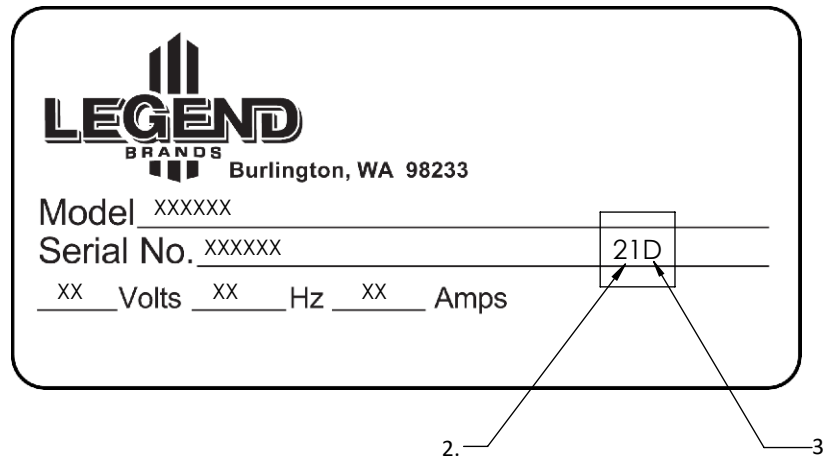

1. THE DATE CODE CAN BE FOUND ON THE RIGHT SIDE OF THE SERIAL NUMBER LINE
2. THE FIRST PORTION OF THE DATE CODE REPRESENTS THE LAST TWO DIGITS OF THE YEAR IN WHICH THE PRODUCT WAS MANUFACTURED
3. THE SECOND PORTION OF THE DATE CODE REPRESENTS THE MONTH IN WHICH THE PRODUCT WAS MANUFACTURED. THE MONTHS ARE REPRESENTED BY LETTERS OUTLINED IN THE TABLE BELOW.

LETTER	MONTH
A	JANUARY
B	FEBRUARY
C	MARCH
D	APRIL
E	MAY
F	JUNE
G	JULY
H	AUGUST
I	SEPTEMBER
J	OCTOBER
K	NOVEMBER
L	DECEMBER

NOTE:

SERIAL LABEL DETAILS (I.E. BRANDING, SPECIFICATIONS, ETC.) ARE SUBJECT TO CHANGE BASED ON THE PRODUCT